

PRINTING AND FITTING SPECIFICATIONS

- Print this document on A4 sheets of paper (21 x 29.7cm).
- Ensure you print at 100 % scale.
- Measure both sides of this box to check scale is correct.
- Fit the prints together following the numbering system on the edge of each sheet. Ensure crosses are aligned.
- Tape the sheets together and cut around the Pack's outline
- When fitting this printed template to your bike, keep in mind that the Frame Pack will be more flexible as it is built from fabric.

10cm
3.9in

10cm / 3.9in

SCALE EXAMPLE OF FINAL TEMPLATE

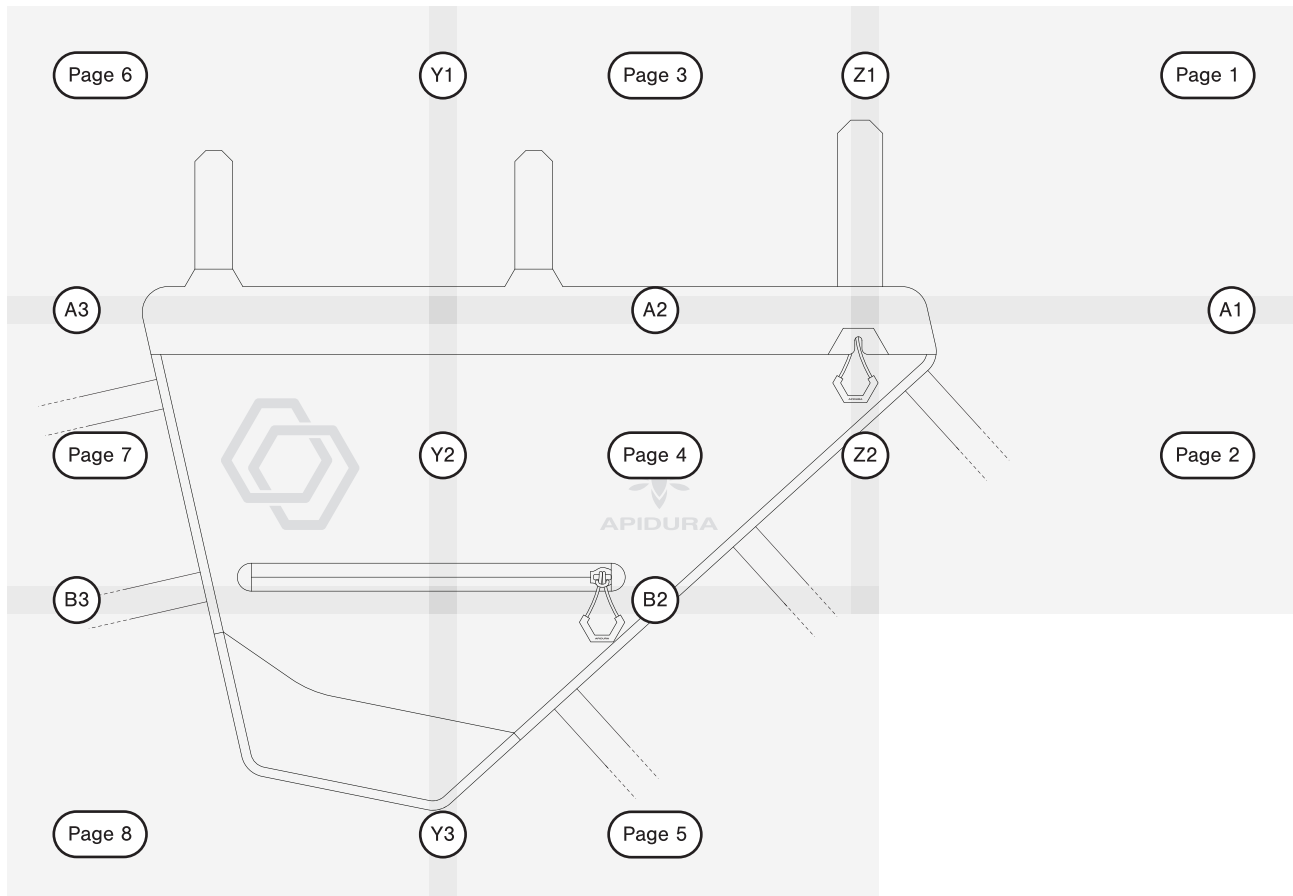

A1
X

X Z1

X

A1
✕

This webbing strap is
26cm long (10.2in long)

✕

✕ Z2

✕

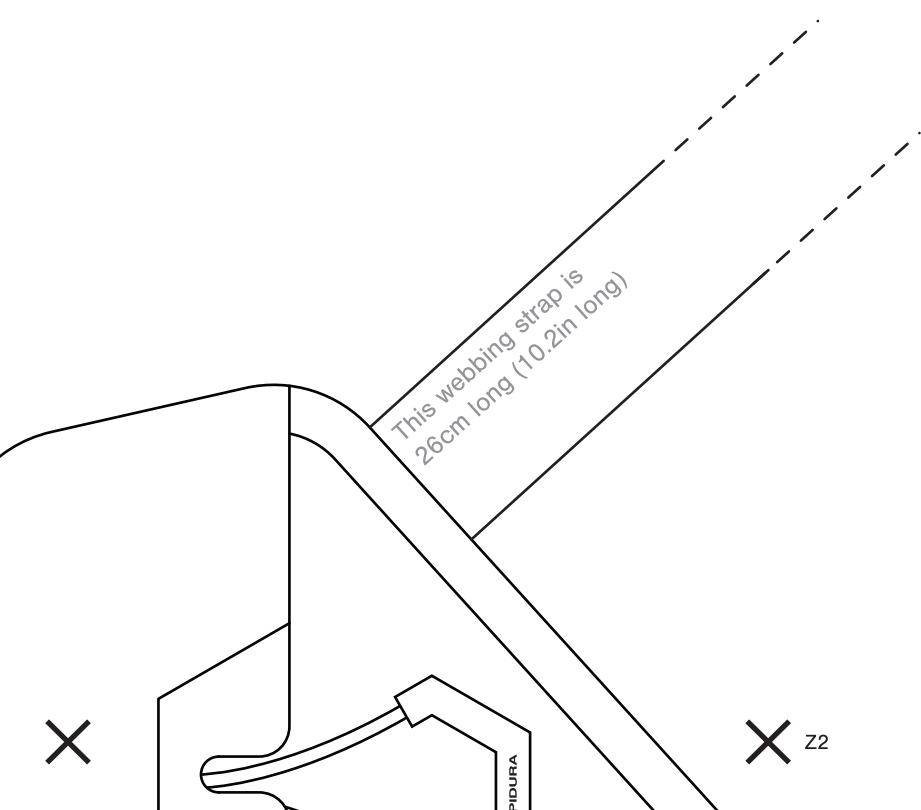

X Z1

X

.....
Alternative placement
for the velcro strap
.....

A2
X

X Y1

X

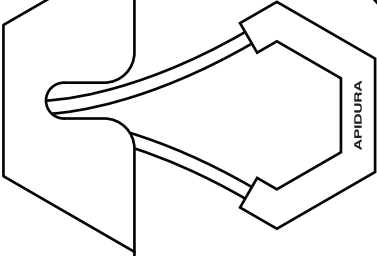

This webbing strap is 26cm long (10.2in long)



APIDURA

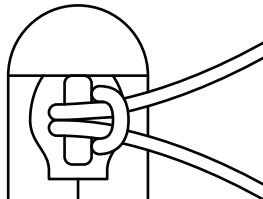

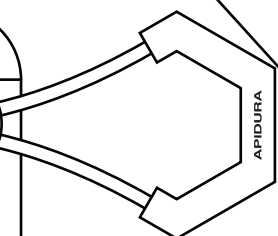
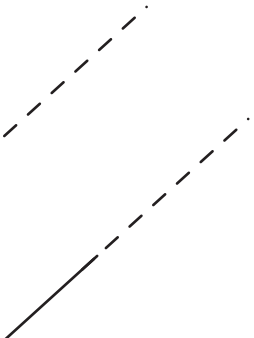

This webbing strap is
26cm long (10.2in long)



X Y1

X

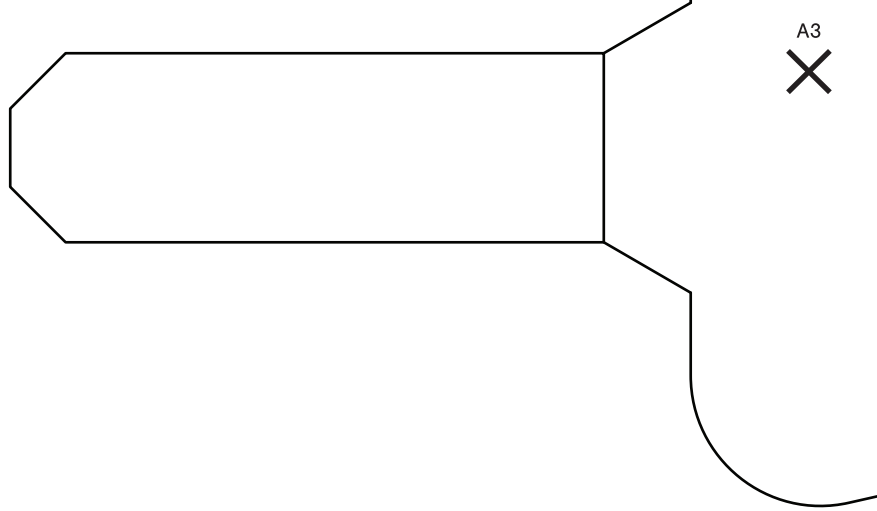

A3
X



EXPEDITION FULL FRAME PACK (12L)

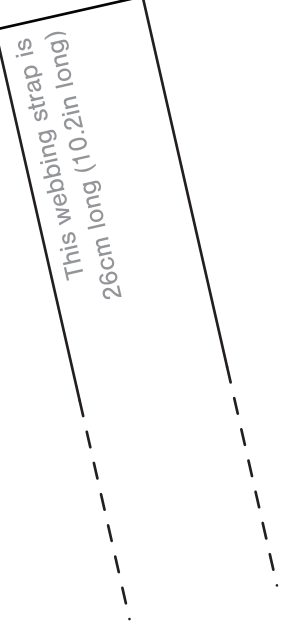
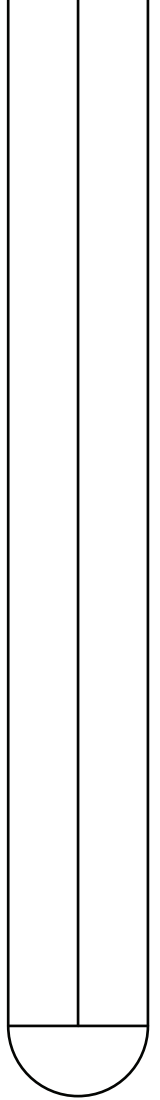

This webbing strap is
26cm long (10.2in long)



This webbing strap is
26cm long (10.2in long)

